

Article number: 207321M81010NI  
Description: E+G Shoulder screw  
GN 732.1-M8-10-10-NI

## Measures

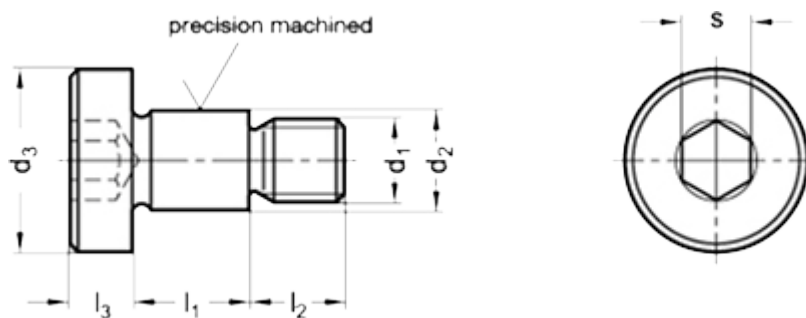

### Application example



$d_1$	= M 8
$d_2$	= 10 -0.05/-0.08
$d_3$	= 16
$l_1 + 0.20/+0.13$	= 10
$l_2$	= 11
$l_3$	= 5
$s$	= 5
Weight in (g)	= 15